

vtech[®]

User's Manual

Go! Go! Smart Wheels[®]

Levels & Ramps Track Set[™]



© 2016 VTech
All rights reserved
Printed in China
91-003233-006 (US)

Dear Parent,

Welcome to the world of **Go! Go! Smart Wheels®**! We're excited you've decided to ride along with us and explore all that **Go! Go! Smart Wheels®** has to offer. These toys have been designed to give your child a thrilling learning experience with hours and hours of fun as well.

Go! Go! Smart Wheels® features vehicles that interact with your child by lighting up, singing and talking, while teaching your child letters and vehicle names (each sold separately). There are other surprises in store, too! With our innovative **SmartPoint®** technology, available on **Go! Go! Smart Wheels®** playsets (each sold separately), your child will smile as they hear **SmartPoint®** vehicles respond to each unique **SmartPoint®** location with singing, sound effects and fun phrases.

Our **Go! Go! Smart Wheels®** playsets also feature buttons, gears and other mechanical features to encourage the development of your child's fine motor skills. Many of the playsets also have tracks that can be arranged in endless ways, stimulating your child's creativity. In addition, all the **Go! Go! Smart Wheels®** playsets connect to other playsets in the collection, so there's no end to what your child can do!

With **Go! Go! Smart Wheels®**, it's playtime with miles of learning!™

Sincerely,
Your friends at **VTech®**

To learn more about **VTech®** toys, visit vtechkids.com

INTRODUCTION

Thank you for purchasing the **VTech® Go! Go! Smart Wheels® Levels & Ramps Track Set™**.

The possibilities are endless with the **Go! Go! Smart Wheels® Levels & Ramps Track Set™!** Use the tracks, ramps and supports to create awesome multilevel courses.

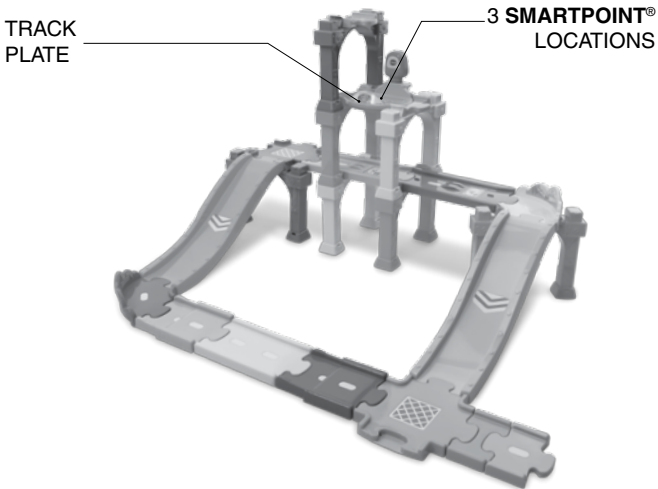

INCLUDED IN THIS PACKAGE



- Two **SmartPoint**[®] straight tracks
- One **SmartPoint**[®] turning plate
- One turning plate base track

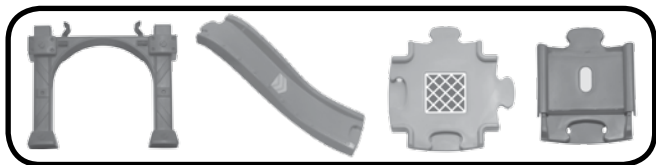

- Seven track supports
- Two ramp tracks
- Two cross tracks
- Two adjustable straight tracks

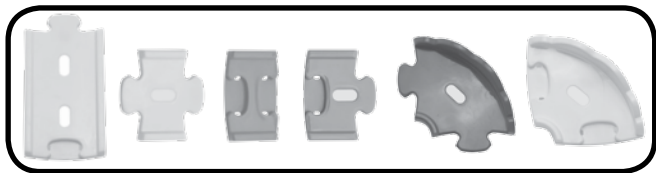

- One 3/4 straight track
- One 1/4 straight track, male
- One 1/4 straight track, female
- One 1/4 straight track
- One 90-degree track, male
- One 90-degree track, female

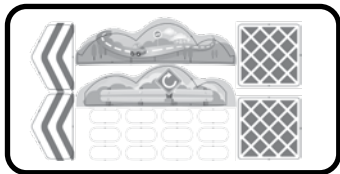

One label sheet

User's manual

WARNING:

All packing materials, such as tape, plastic sheets, packaging locks and tags are not part of this toy, and should be discarded for your child's safety.

ATTENTION:

Pour la sécurité de votre enfant, débarrassez-vous de tous les produits d'emballage tels que rubans adhésifs, feuilles de plastique, attaches et étiquettes. Ils ne font pas partie du jouet.

NOTE:

1. Please keep this user's manual as it contains important information.
2. Levels & Ramps Track Set™ is compatible with standard tracks. The tracks are not compatible with snap tracks.
3. SmartPoint® vehicles respond to SmartPoint® locations with different phrases, music or fun sound effects. Each sold separately.

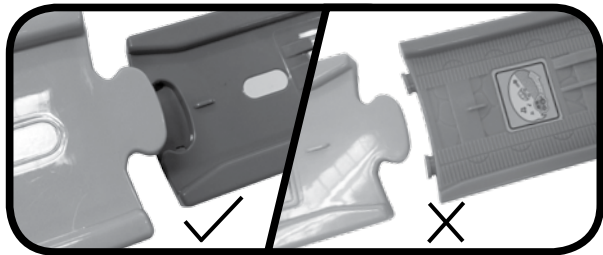

Building Tips

When attaching a track piece to a **TRACK SUPPORT**, insert the track into one side of the **TRACK SUPPORT** at an angle. Once one corner of the track is on the inside of a **TRACK SUPPORT** tooth, straighten the track so the other corner fits inside the other **TRACK SUPPORT** tooth as show below.



1. Build track configurations on a smooth, hard surface for best results.
2. Do not build configurations that are more than three levels.
3. Do not use these track pieces with **Go! Go! Smart Wheels**[®] motorized or RC vehicles.
4. For maximum stability, place the track supports where the track pieces join together as shown below.

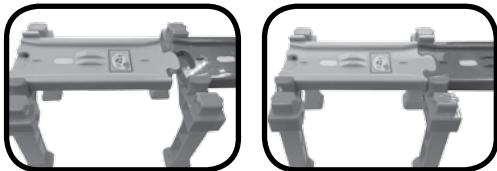

- Three track supports are necessary when joining two or three tracks together.

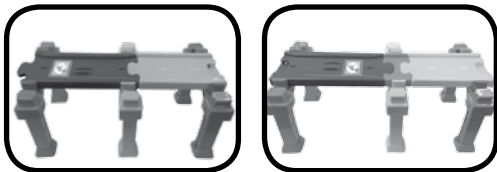

- Placing the track supports in the middle or near the ends of the tracks gives more stability to the structure.



- One track support is necessary for every 90-degree or 60-degree track that is used.



- Two track supports are necessary for every cross track that is used.

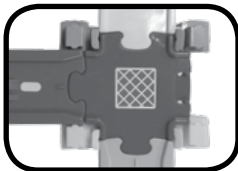

5. To ensure the stability of the track pieces, when building a ramp, we strongly recommend using a cross track or a 90-degree track to connect the tracks.

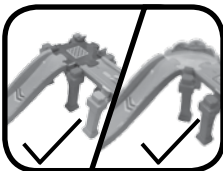

- Do not lean on vertically built structures.
- The support pieces have a locking mechanism to ensure the stability of the track pieces. Some children may require adult assistance to assemble and disassemble track configurations that use track supports.

Attaching labels to the track pieces should be done by an adult. Please adhere the labels to the track set as indicated on the following page:

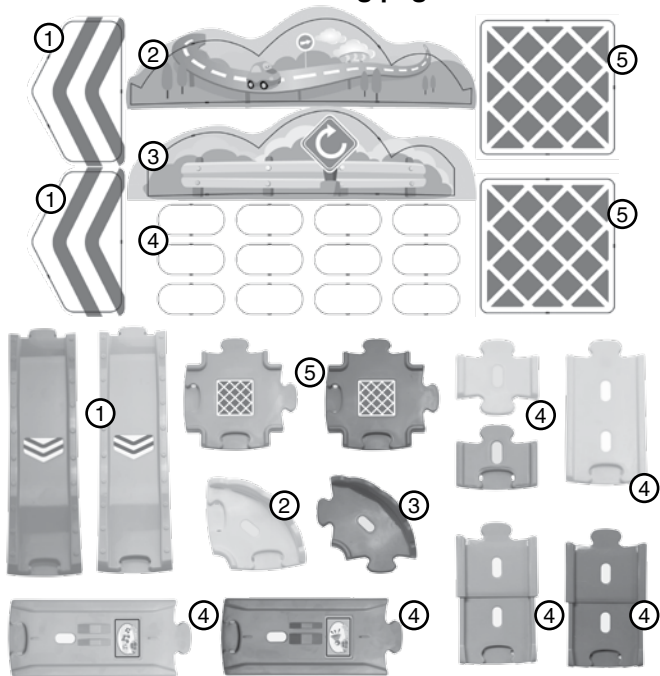

Expand & Explore

Connect to other **Go! Go! Smart Wheels®** and **Go! Go! Smart Animals®** playsets (each sold separately) to expand them and inspire creativity.

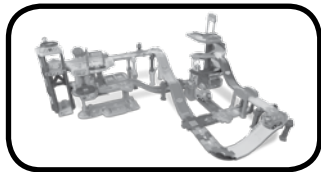
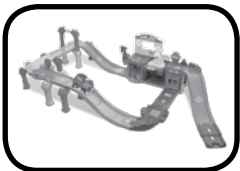
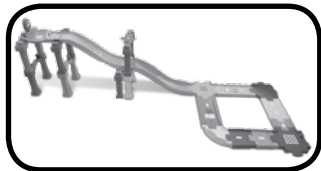
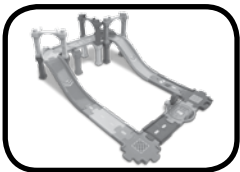

TROUBLESHOOTING

If you encounter any issues or problems, please call our Consumer Services Department at 1-800-521-2010 in the U.S. or 1-877-352-8697 in Canada, or by going to our website at www.vtechkids.com and filling out our Contact Us form located under the Customer Support link. A service representative will be happy to help you.

IMPORTANT NOTE:

Creating and developing Infant Learning products is accompanied by a responsibility that we at VTech® take very seriously. We make every effort to ensure the accuracy of the information, which forms the value of our products. However, errors sometimes can occur. It is important for you to know that we stand behind our products and encourage you to call our Consumer Services Department at 1-800-521-2010 in the U.S. or 1-877-352-8697 in Canada, or by going to our website at www.vtechkids.com and filling out our Contact Us form located under the Customer Support link with any problems and/or suggestions that you might have. A service representative will be happy to help you.



PRODUCT WARRANTY

This Warranty is applicable only to the original purchaser, is non-transferable and applies only to "VTech" products or parts. This product is covered by a 3-month Warranty from the original purchase date, under normal use and service, against defective workmanship and materials. This Warranty does not apply to (a) consumable parts, such as batteries; (b) cosmetic damage, including but not limited to scratches and dents; (c) damage caused by use with non-VTech products; (d) damage caused by accident, misuse, unreasonable use, immersion in water, neglect, abuse, battery leakage, or improper installation, improper service, or other external causes; (e) damage caused by operating the product outside the permitted or intended uses described by VTech in the owner's manual; (f) a product or part that has been modified (g) defects caused by normal wear and tear or otherwise due to the normal aging of the product; or (h) if any VTech serial number has been removed or defaced.

Prior to returning a product for any reason, please notify the VTech Consumer Services Department by going to our website at www.vtechkids.com, filling out our Contact Us form located under the Customer Support link or calling 1-800-521-2010.

If the service representative is unable to resolve the issue, you will be provided instructions on how to return the product and have it replaced under Warranty. Return of the product under Warranty must adhere to the following rules: If VTech believes that there may be a defect in the materials or workmanship of the product and can confirm the purchase date and location of the product, we will at our discretion replace the product with a new unit or product of comparable value. A replacement product or parts assumes the remaining Warranty of the original product or 30 days from the date of replacement, whichever provides longer coverage.

THIS WARRANTY AND THE REMEDIES SET FORTH ABOVE ARE EXCLUSIVE AND IN LIEU OF ALL OTHER WARRANTIES, REMEDIES AND CONDITIONS, WHETHER ORAL, WRITTEN, STATUTORY, EXPRESS OR IMPLIED. IF VTECH CANNOT LAWFULLY DISCLAIM STATUTORY OR IMPLIED WARRANTIES THEN TO THE EXTENT PERMITTED BY LAW, ALL SUCH WARRANTIES SHALL BE LIMITED TO THE DURATION OF THE EXPRESS WARRANTY AND TO THE REPLACEMENT SERVICE AS DETERMINED BY VTECH IN ITS SOLE DISCRETION.

To the extent permitted by law, VTech will not be responsible for direct, special, incidental or consequential damages resulting from any breach of Warranty.

This Warranty is not intended to persons or entities outside the United States of America. Any disputes resulting from this Warranty shall be subject to the final and conclusive determination of VTech.